

CLAMPOR®



18V CORDLESS STAPLER/NAILER

MODEL NO: CONSN18LIC

PART NO: 6487058

OPERATION & MAINTENANCE INSTRUCTIONS



ORIGINAL INSTRUCTIONS

LS0818 ISS3

INTRODUCTION

Thank you for purchasing this CLARKE product.

Before attempting to use this product, please read this manual thoroughly and follow the instructions carefully. In doing so you will ensure the safety of yourself and that of others around you, and you can look forward to your purchase giving you long and satisfactory service.

INTENDED USE

The machine is intended for the tacking of cardboard, insulating material, fabrics, foils, leather and similar materials on surfaces of wood or materials similar to wood.

GUARANTEE

This product is guaranteed against faulty manufacture for a period of 12 months from the date of purchase. Please keep your receipt which will be required as proof of purchase.

This guarantee is invalid if the product is found to have been abused or tampered with in any way, or not used for the purpose for which it was intended.

Faulty goods should be returned to their place of purchase, no product can be returned to us without prior permission.

This guarantee does not effect your statutory rights.

ENVIRONMENTAL RECYCLING POLICY



Through purchase of this product, the customer is taking on the obligation to deal with the WEEE in accordance with the WEEE regulations in relation to the treatment, recycling & recovery and environmentally sound disposal of the WEEE.

In effect, this means that this product must not be disposed of with general household waste. It must be disposed of according to the laws governing Waste Electrical and Electronic Equipment (WEEE) at a recognised disposal facility.

GENERAL POWER TOOL SAFETY WARNINGS



WARNING: READ ALL SAFETY WARNINGS AND ALL INSTRUCTIONS. FAILURE TO FOLLOW THE WARNINGS AND INSTRUCTIONS MAY RESULT IN ELECTRIC SHOCK, FIRE AND/OR SERIOUS INJURY.

WARNING: SAVE ALL WARNINGS AND INSTRUCTIONS FOR FUTURE REFERENCE.

WARNING: THE TERM “POWER TOOL” IN THE WARNINGS REFERS TO YOUR MAINS-OPERATED (CORDED) POWER TOOL OR BATTERY-OPERATED (CORDLESS) POWER TOOL.

WORK AREA SAFETY

1. **Keep work area clean and well lit.** Cluttered or dark areas invite accidents.
2. **Do not operate power tools in explosive atmospheres, such as in the presence of flammable liquids, gases or dust.** Power tools create sparks which may ignite the dust or fumes.
3. **Keep children and bystanders away while operating a power tool.** Distractions can cause you to lose control.

ELECTRICAL SAFETY

1. **Power tool plugs must match the outlet. Never modify the plug in any way. Do not use any adapter plugs with earthed (grounded) power tools.** Unmodified plugs and matching outlets will reduce risk of electric shock.
2. **Avoid body contact with earthed or grounded surfaces, such as pipes, radiators, ranges and refrigerators.** There is an increased risk of electric shock if your body is earthed or grounded.
3. **Do not expose power tools to rain or wet conditions.** Water entering a power tool will increase the risk of electric shock.
4. **Do not abuse the cord. Never use the cord for carrying, pulling or unplugging the power tool. Keep cord away from heat, oil, sharp edges or moving parts.** Damaged or entangled cords increase the risk of electric shock.
5. **When operating a power tool outdoors, use an extension cord suitable for outdoor use.** Use of a cord suitable for outdoor use reduces the risk of electric shock.
6. **If operating a power tool in a damp location is unavoidable, use a residual current device (RCD) protected supply.** Use of an RCD reduces the risk of electric shock.

PERSONAL SAFETY

1. **Stay alert, watch what you are doing and use common sense when operating a power tool. Do not use a power tool while you are tired or under the influence of drugs, alcohol or medication.** A moment of inattention while operating power tools may result in serious personal injury.
2. **Use personal protective equipment. Always wear eye protection.** Protective equipment such as dust mask, non-skid safety shoes, hard hat, or hearing protection used for appropriate conditions will reduce personal injuries.
3. **Prevent unintentional starting. Ensure the switch is in the off position before connecting to power source and / or battery pack, picking up or carrying the tool.** Carrying power tools with your finger on the switch or energising power tools that have the switch on invites accidents.
4. **Remove any adjusting key or wrench before turning the power tool on.** A wrench or a key left attached to a rotating part of the power tool may result in personal injury.
5. **Do not overreach. Keep proper footing and balance at all times.** This enables better control of the power tool in unexpected situations.
6. **Dress properly. Do not wear loose clothing or jewellery. Keep your hair, clothing and gloves away from moving parts.** Loose clothes, jewellery or long hair can be caught in moving parts.
7. **If devices are provided for the connection of dust extraction and collection facilities, ensure these are connected and properly used.** Use of dust collection can reduce dust-related hazards.

POWER TOOL USE AND CARE

1. **Do not force the power tool. Use the correct power tool for your application.** The correct power tool will do the job better and safer at the rate for which it was designed.
2. **Do not use the power tool if the switch does not turn it on and off.** Any power tool that cannot be controlled with the switch is dangerous and must be repaired.
3. **Disconnect the plug from the power source and/or the battery pack from the power tool before making any adjustments, changing accessories, or storing power tools.** Such preventive safety measures reduce the risk of starting the power ~ tool accidentally.
4. **Store idle power tools out of the reach of children and do not allow persons unfamiliar with the power tool or these instructions to operate the power tool.** Power tools are dangerous in the hands of untrained users.
5. **Maintain power tools. Check for misalignment or binding of moving parts, breakage of parts and any other condition that may affect the power tool's**

operation. If damaged, have the power tool repaired before use. Many accidents are caused by poorly maintained power tools.

6. **Keep cutting tools sharp and clean.** Properly maintained cutting tools with sharp cutting edges are less likely to bind and are easier to control.
7. **Use the power tool, accessories and tool bits etc. in accordance with these instructions, taking into account the working conditions and the work to be performed.** Use of the power tool for operations different from those intended could result in a hazardous situation.

SERVICE

1. **Have your power tool serviced by a qualified repair person using only identical replacement parts.** This will ensure that the safety of the power tool is maintained

STAPLER/NAILER SPECIFIC SAFETY WARNINGS

1. Always assume that the tool contains fasteners. Careless handling of the stapler/nailer can result in unexpected firing of fasteners and personal injury.
2. Do not point the tool towards yourself or anyone nearby. Unexpected triggering will discharge the fastener causing an injury.
3. Do not actuate the tool unless the tool is placed firmly against the workpiece. If the tool is not in contact with the workpiece, the fastener may be deflected away from your target.
4. Disconnect the tool from the power source when the fastener jams in the tool. While removing a jammed fastener, the tacker may be accidentally activated if it is plugged in.
5. Do not use this stapler/nailer for fastening electrical cables. It is not designed for electric cable installation and may damage the insulation of electric cables thereby causing electric shock or fire hazards.

SAFETY SYMBOLS.

	Read manual before use		Wear suitable eye protection		Class II appliance
	Indoor Use Only		Wear Hearing Protection		Do not immerse in liquid
	Isolation transformer		Do not use when on scaffolding or ladders		Do not incinerate

HOW TO CHARGE THE BATTERY



WARNING: THE BATTERY CAN BE WARM TO THE TOUCH WHEN REMOVED FROM THE TOOL. ALWAYS LET THE BATTERY COOL DOWN BEFORE RECHARGING. DO NOT RECHARGE A WARM BATTERY.

NOTE: New batteries must be charged before use.

1. Connect the battery charger to the power supply.
 - The green LED comes on.
2. Put the battery into the charger as shown.
 - The red LED comes on and the green LED goes out.
 - Charging takes approximately 45-60 minutes.
 - When fully charged the green LED comes back on.
3. Disconnect the charger from the power supply.

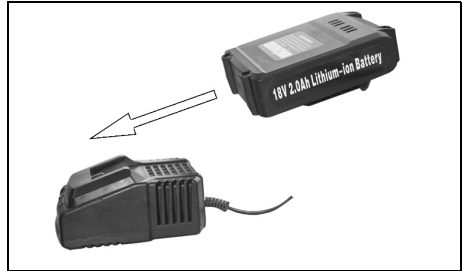

FITTING THE BATTERY PACK

TO ATTACH THE BATTERY

1. Slide the battery into the stapler/nailer until it clicks into position.



TO REMOVE THE BATTERY

1. Push and hold the release button on the battery.
2. Remove the battery from the stapler/nailer.



BEFORE USE

PUT THE STAPLES OR NAILS INTO THE MAGAZINE

NOTE: Do not mix different sized fasteners, do not put both staples and nails into the magazine at the same time.

1. Remove the battery from the stapler/nailer
2. Push the release button and pull out the magazine.
3. Put the nails/staples into the magazine as shown.
 - Staples: Put the top of the staple against the top of the magazine
 - Nails: Put the bottom of the nails at the bottom of the magazine and flat against the rear.
4. Close the magazine until it engages with the release button.
5. Re-attach the battery.

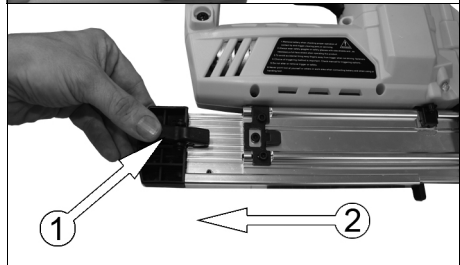

Insert Staples

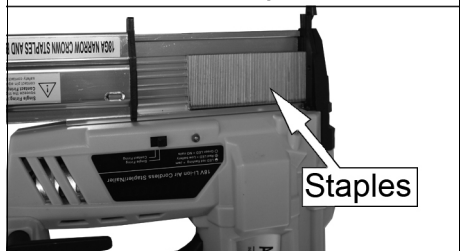

Insert Nails

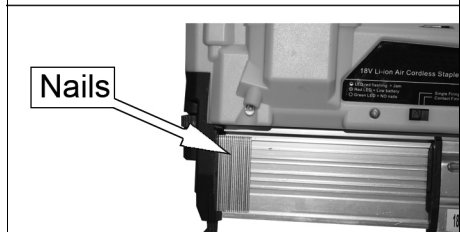

FASTENERS AVAILABLE FROM CLARKE STOCKISTS

NAILS	Part No	STAPLES	Part No
CL NAIL 20mm 18G 1.2	1800415	CL STAPLE TYPE90 19mm	1800431
CL NAIL 30mm 18G 1.2	1800417	CL STAPLE TYPE90 25mm	1800435
CL NAIL 35mm 18G 1.2	1800421	CL STAPLES TYPE90 32mm	1800436
CL NAIL 40mm 18G 1.2	1800423	CL STAPLES TYPE90 40mm	1800437
CL NAIL 50mm 18G 1.2	1800427		

USING THE STAPLER/NAILER

LED INDICATOR:

- Red LED flashes = the nails/ staples are jammed.
- Red LED on = low battery
- Green LED on = No nails/ staples, tool is in dry fire protection.
- Green LED flashing = Overheat. The tool can not fire in this situation, return to work after it has cooled down.

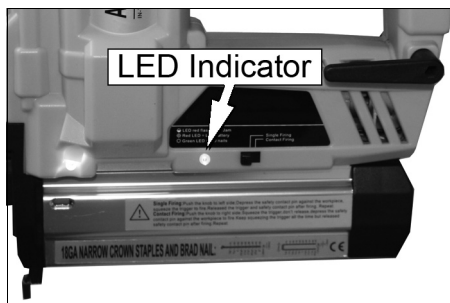

DEPTH ADJUSTMENT WHEEL

The depth adjustment wheel lets you to correctly set the depth of the nail heads.

1. Turn the depth adjustment wheel to the left to increase the depth of the nail/staple.
2. Turn the depth adjustment wheel to the right to decrease the depth of the nail/staple.

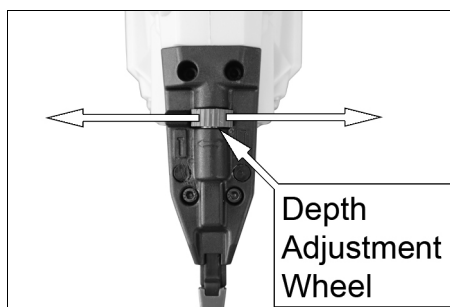

FIRING MODES

ONE SHOT MODE

1. Set the firing mode switch to the left (single firing).
 - This mode is ideal for the precision placement of the fasteners
2. Push the safety yoke against the work piece.
 - The safety yoke must be pressed against the work piece before you pull the trigger.
3. Pull the trigger to fire the staple or nail.
4. Release the trigger and lift the tool away from the workpiece.
5. Repeat step 2 and step 3 to fire the next staple or nail.

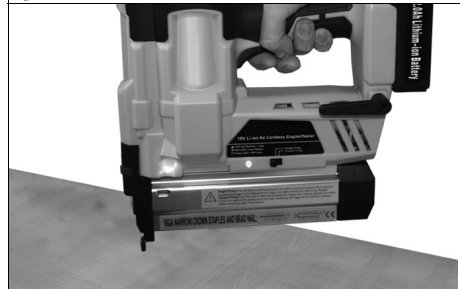
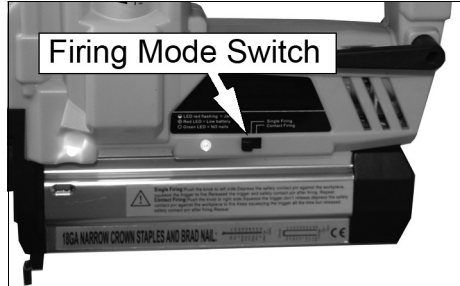

CONTACT FIRING MODE

1. Push the firing mode switch to right (contact firing).
 - This mode is ideal for quick firing.
2. Pull the trigger, keep squeezing and don't release it.
3. Push the safety yoke against the work piece to fire the nail or staple.
4. Keep squeezing the trigger and lift the tool away from the workpiece.
5. To fire the next staple or nail, repeat step 3.

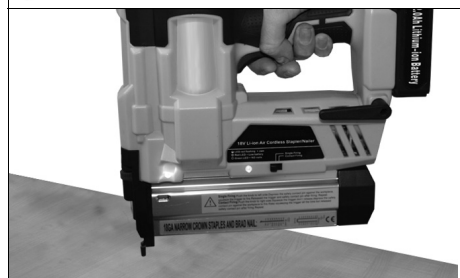
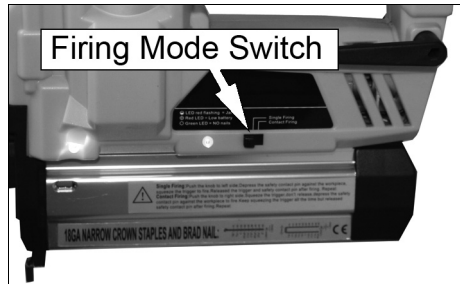

To prevent accidental firing, Do not pull the trigger when the tool is not in use.

TO CLEAR A JAM



WARNING: REMOVE THE BATTERY FROM THE STAPLER/NAILER BEFORE CARRYING OUT ANY SERVICING OR MAINTENANCE

WARNING: DO NOT PULL THE TRIGGER UNTIL THE JAM HAS BEEN CLEARED.

1. Remove the battery from the stapler/nailer.
2. Open the magazine.
3. Remove all staples/nails from the magazine.
4. If a staple or nail is stuck, loosen the hex screws shown with the tools supplied.
5. Remove the jammed staples or nails.
 - Use pliers if necessary.
6. Re-tighten the hex screws.
7. Reload the stapler/nailer, install the battery and continue.

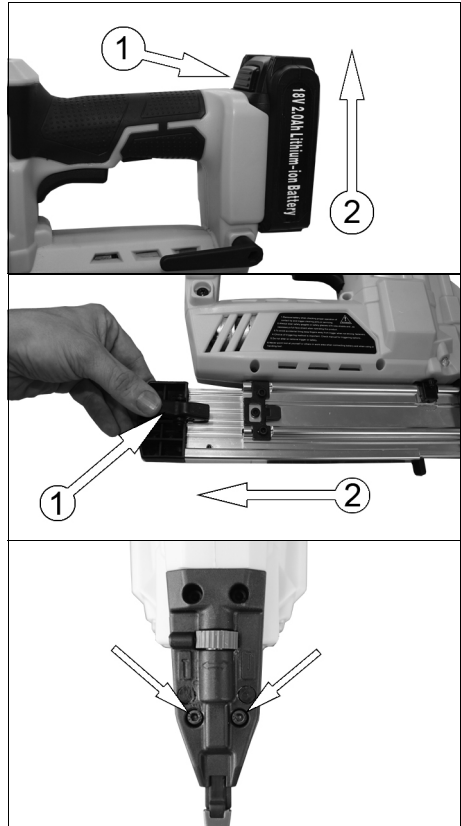

MAINTENANCE



WARNING: REMOVE THE BATTERY FROM THE STAPLER/NAILER BEFORE CARRYING OUT ANY SERVICING OR MAINTENANCE

- Use a clean dry cloth or brush to keep the stapler/nailer clean and free of dirt. Do not use solvent or alcohol based cleaners as they could damage the casing.
- There are no user serviceable parts on the stapler/nailer. If there is a problem speak to your nearest CLARKE dealer.
- Do not open the casing, the guarantee will be void if the casing has been opened or if the stapler/nailer has been tampered with.
- The use of parts other than CLARKE replacement parts may result in safety hazards, decreased tool performance and will invalidate your warranty.

SPECIFICATION

Input Voltage	18V DC
Max Firing Speed	100 Nails/min.
Maximum Magazine Capacity	100 Nails or 100 Staples
Nail Type	18 Gauge (F-Type) 20-50mm
Staple Type	Type 90 19 - 40 mm
Dimensions	285 x 274 x 96 mm
Weight inc battery	2.9 kg
Activation Mode	Full sequential actuation / contact actuation
Noise Characteristic Values In Accordance With EN12549.	
Sound Pressure:	80 dB(A)
Sound Power Measured LwA	91 dBLwA
Vibration Characteristic Values In Accordance With ISO 8662-1 1: 1999	1.39 m/s ²

DECLARATION OF CONFORMITY



Clarke[®]
INTERNATIONAL

Hemnal Street, Epping, Essex CM16 4LG

DECLARATION OF CONFORMITY

This is an important document and should be retained.

We hereby declare that this product(s) complies with the following directive(s):

- 2014/30/EC *Electromagnetic Compatibility Directive.*
- 2006/42/EC *Machinery Directive.*
- 2011/65/EU *Restriction of Hazardous substances.*

The following standards have been applied to the product(s):

- EN 55014-1:2006 +A2:2011, EN 55014-2:1997 +A2:2008, EN 60745-1:2009 +A11:2010,
EN 60745-2-16:2010.

The technical documentation required to demonstrate that the product(s) meet(s) the requirement(s) of the aforementioned directive(s) has been compiled and is available for inspection by the relevant enforcement authorities.

The CE mark was first applied in: 2016

Product Description: Cordless - Air 18V Lithium Ion 18V Nailer / Stapler.
Model number(s): CONSN18LIC.
Serial / batch Number: N/A
Date of Issue: 29/11/2016

Signed:



.....

J.A. Clarke
Director

A SELECTION FROM THE VAST RANGE OF

Clarke®

QUALITY PRODUCTS

AIR COMPRESSORS

From DIY to industrial, Plus air tools, spray guns and accessories.

GENERATORS

Prime duty or emergency standby for business, home and leisure.

POWER WASHERS

Hot and cold, electric and engine driven - we have what you need

WELDERS

Mig, Arc, Tig and Spot. From DIY to auto/industrial.

METALWORKING

Drills, grinders and saws for DIY and professional use.

WOODWORKING

Saws, sanders, lathes, mortisers and dust extraction.

HYDRAULICS

Cranes, body repair kits, transmission jacks for all types of workshop use.

WATER PUMPS

Submersible, electric and engine driven for DIY, agriculture and industry.

POWERTOOLS

Angle grinders, cordless drill sets, saws and sanders.

STARTERS/CHARGERS

All sizes for car and commercial use.

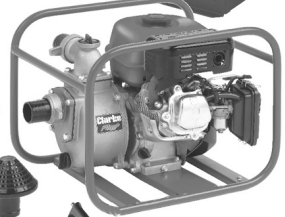

PARTS & SERVICE: 0208 988 7400
E-mail: Parts@clarkeinternational.com or Service@clarkeinternational.com
SALES: UK 01992 565333 or Export 00 44 (0)1992 565335

Clarke® INTERNATIONAL Hemnall Street, Epping, Essex CM16 4LG
www.clarkeinternational.com